

Operating Instructions

Series TB Tool Balancers

Model Numbers:

TB 01 TB 03 TB 05

Dimensions

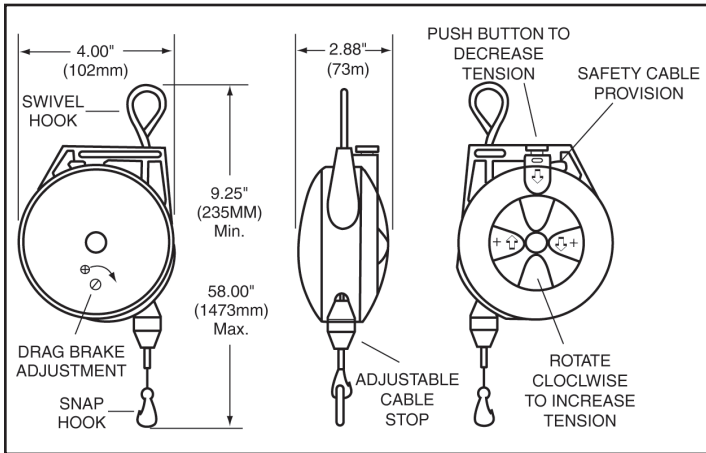

Safety Clip - 261241

Bright zinc plated steel cable and safety latch for tool attachment and other uses. Measures 2.375" (60 mm) long. Included with each model.

Installation Instructions:

1. Mount reel to secure structure directly above work. **NOTE:** Disregard this step if reel is pre-mounted to Torq-Arm or other equipment. (Figure 1a and 1b)
2. Raise tool and attach to hook on end of cable. **CAUTION:** Do not pull cable down. It is spring loaded and could cause injury if allowed to snap back. (Figure 2a and 2b)
3. Be sure tool is securely hooked to cable. Do not drop tool. Tool may be heavier than spring can lift before spring is adjusted. (Figure 3)

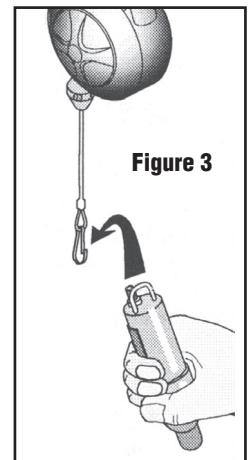
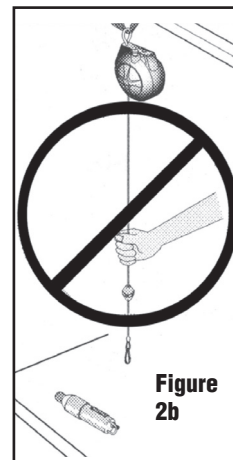
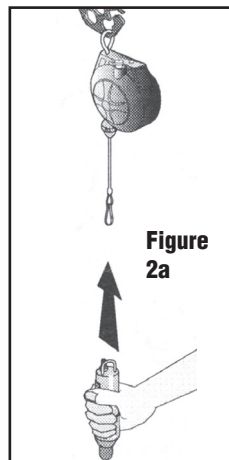
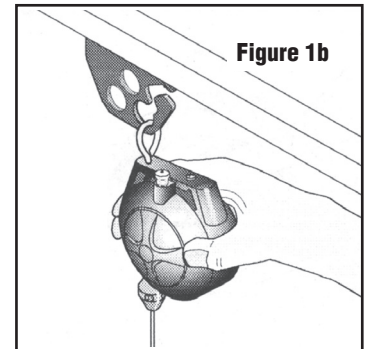
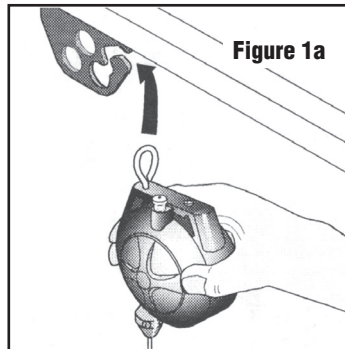

Form# 1270-1112 Rev: 10/2018

4. Determine ideal height for tool when tool is not in use. (Figure 4)
5. Slide ball stop up or down cable to hold tool at determined height. Keep a minimum of 3 inches between ball stop and end of cable. (Figure 5)
6. To **INCREASE** spring tension, turn “palm knob” clockwise until tool rises to ball stop. (Figure 6)
7. To **DECREASE** spring tension, repeatedly depress button on top of the reel. (Figure 7)
8. Drag brake adds friction to the spool and allows you to fine tune the reel. Add or subtract friction by turning screw on back of reel. (Figure 8)
9. It is recommended that a safety cable be installed to a second support in the unlikely event of failure of the first mounting point. (Figure 9)

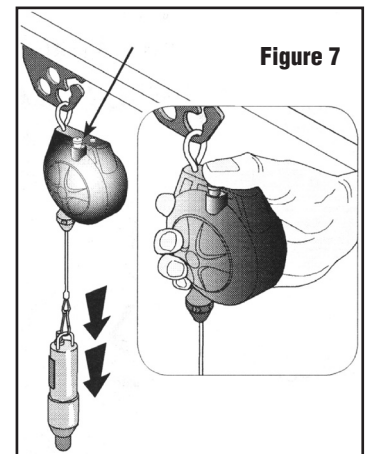
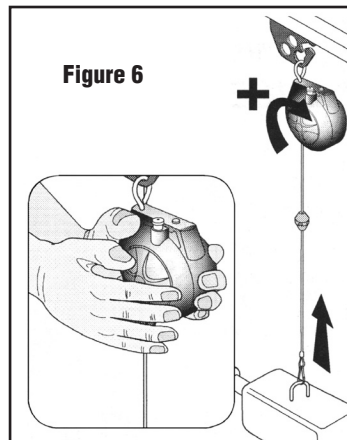
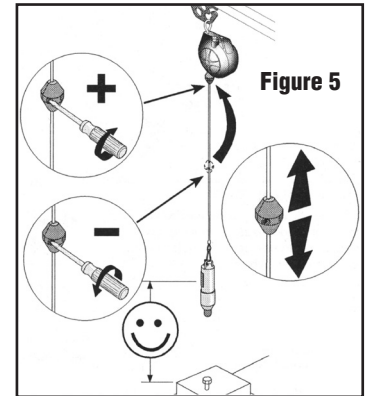
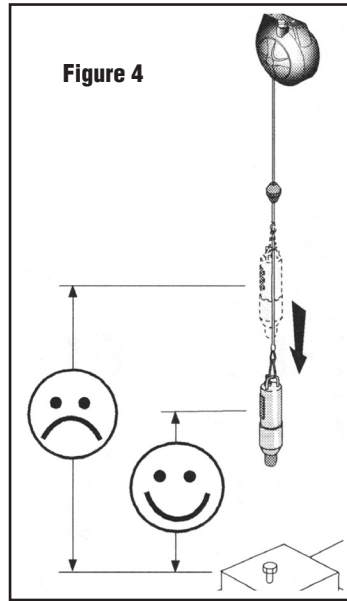

Periodically inspect cable and hook for wear and looseness. Replace unit if required. Do not lubricate; balance reel is permanently lubricated. **CAUTION:** Do not attempt to remove spring from its canister. Damage or personal injury could result.

Optional Accessories

- 261241** - Safety clip
 - S602413** - Replacement bumper
 - 600603** - Safety cable (1 ft / 30.5 cm)
 - 600605-3** - Overhang cable (3 ft / 91.5 cm)
 - 600605-5** - Overhang cable (5 ft / 152.4 cm)
- Cables can be combined for added length.

